

WhisperCeiling™

VENTILATION FAN

FV-05VQ5, FV-08VQ5, FV-11VQ5, FV-15VQ5,
FV-20VQ3, FV-30VQ3, FV-40VQ3

WhisperLite®

VENTILATION FAN

FV-08VQL5, FV-11VQL5, FV-15VQL5

A new generation of energy efficiency, quiet operation and unparalleled performance.

- Meets ASHRAE 62.2 guidelines that requires any fan used for whole house continuous ventilation to be rated at .25" w.g.
- Contemporary flush-mount grille for WhisperLite series
- ENERGY STAR® rated fan and light fixture
- **Detachable dual 4" or 6" diameter duct adaptor on selected models** (FV-05VQ5, FV-08VQ5, FV-11VQ5, FV-08VQL5, FV-11VQL5)



FV-08VQ5



FV-11VQL5

Panasonic ideas for life



Whisper Ceiling/Whisper Lite Ventilation Fans

Power of Performance, Efficiency Perfected.

• Quiet Operation at .25" Water Gauge

Any manufacturer can achieve low sone levels at .1" w.g. - the amount of static pressure with 10 feet of duct and a wall cap. But today's houses have longer and more complicated duct runs. Since .1" w.g. is an unrealistic amount of static pressure when installed, ASHRAE, ENERGY STAR®, and LEED for Homes, have set the industry standard for performance measurement at .25" w.g. Panasonic leads the way with incomparable sone levels at both .1" and .25" w.g.

• Contemporary Flush-Mount Grille

WhisperLite models now feature a flush mount grille that incorporates a 32-Watt ENERGY STAR® rated CFL light fixture and a 4-Watt night light.

3500 Kelvin/High CRI/2400 Lumens/10,000 hours rated average life/equivalent to (2) 75-Watt incandescent lamp/electronic ballast for flicker-free operation



• **Dual chamber technology** minimizes noise transmission from the blower to exterior on select models.

• **Open hub structure** substantially improves the fan's aerodynamics

Additional Benefits

- ASHRAE 62.2, ENERGY STAR®, LEED for Homes, and CA Title 24 compliant
- Easy installation (double hanger bar system)
- Rust-proof paint treatment on galvanized housing
- Built-in damper to prevent backdraft
- Fits in 2 x 8 construction
- UL listed for tub/shower enclosure when used with a GFCI branch circuit wire
- Thermal fuse protection
- Meets Washington State Ventilation and Indoor Air Quality Code
- 3 year warranty
- Optional designer grille and radiation damper available for some models

Specifications		WhisperCeiling												WhisperLite								
		FV-05VQ5		FV-08VQ5		FV-11VQ5		FV-15VQ5		FV-20VQ3		FV-30VQ3		FV-40VQ3		FV-08VQL5		FV-11VQL5		FV-15VQL5		
Characteristics (HVI Certified Data for 0.1" S.P.)	Static pressure in inches w. g.	0.1	0.25	0.1	0.25	0.1	0.25	0.1	0.25	190	144	290	257	380	348	0.1	0.25	0.1	0.25	0.1	0.25	
	Air Volume (CFM)	50	36	80	62	110	91	150	127	0.8	1.4	2.0	N/A	3.0	N/A	80	62	110	90	150	128	
	Noise (sones)	<0.3	0.5	<0.3	0.4	<0.3	0.5	<0.3	0.5	42	42	64	62	112	111	<0.3	0.4	0.5	0.6	0.9	1.0	
	Power Consumption (Watts)	11.0	11.5	14.7	14.5	21.1	20.7	28.4	27.3	4.5	3.4	4.6	4.1	3.4	3.1	14.9	14.7	23.4	23.0	31.8	30.9	
	Energy Efficiency (CFMs/Watt)	4.7	3.2	5.8	4.5	5.3	4.5	5.3	4.7	696	871	877	990	736	823	5.5	4.3	4.7	3.9	4.8	4.2	
	Speed	731	1060	829	1089	950	1161	691	911	0.35	0.35	0.53	0.52	0.94	0.92	863	1117	1006	1193	800	988	
	Current	0.09	0.10	0.12	0.12	0.18	0.17	0.24	0.23	0.12	0.12	0.18	0.17	0.24	0.23	0.12	0.12	0.20	0.19	0.27	0.26	
	Power Rating (W/Hz)	120/60												120/60								
Specifications	Motor Type	Condenser												Condenser								
	Type of Motor Bearing	Ball												Ball								
	Thermal Fuse Protection	Yes												Yes								
	Blower Wheel Type	Sirocco												Sirocco								
	ENERGY STAR Qualified	Yes												Yes								
Installation	Duct Diameter (inches)	4 or 6		4 or 6		4 or 6		6						4 or 6		4 or 6		6				
	Mounting Opening (inches sq.)	10-1/2						12-3/16						14-3/4								
	Grille Size (inches sq.)	13		13		13		13		15				17-11/16				13		13		13
Light Specifications	Lamp Watts													1 x 32								
	Color Rendering Index													84								
	Color Temp (Kelvin)													3500								
	Rated Life (hrs)													10,000								
	Lamp Model #													FHT32E35*								
Night-Light Specs	Night Light Watts													4								
Shipping	Gross Weight (lbs.)	10.4		10.4		10.4		11.5		17.2		18.3		27.3		12.6		12.6		13.7		
Approved Code/ Standard/ Regulation	UL Tub/Shower Enclosure	Yes												Yes								
	Washington State VIAQ Code	Yes												Yes								
	California Title 24 Compliant	Yes												Yes								
	Mfg in ISO 9001 Certified Facility	Yes												Yes								
	List Price	\$196.00		\$209.00		\$234.00		\$287.00		\$311.00		\$326.00		\$494.00		\$311.00		\$343.00		\$404.00		

* Lamp contains mercury. Dispose of according to local, state and federal laws.

WhisperCeiling Competitive Cross Reference

Brand	Model Number	Description	Duct	CFM		Sones		Watt	Warranty (yrs)	ENERGY STAR	Housing Depth
				.1" w.g. .25" w.g.	.1" w.g. .25" w.g.						
Panasonic	FV-05VQ5	Fan	4" or 6"	50	36	<0.3	0.5	11.0	3	Y	7-2/5"
Broan	QTXE050	Fan	6"	50	39	<0.3	N/A	19.7	3	Y	7-5/8"
Nutone	QT Xen050	Fan	6"	50	39	<0.3	N/A	19.7	3	Y	7-5/8"
Renewaire	V50	Fan	4"	50	31	<0.3	NA	12.9	5	Y	8-1/16"
Panasonic	FV-08VQ5	Fan	4" or 6"	80	62	<.0.3	0.4	14.7	3	Y	7-2/5"
Air King	ES80S	Fan	6"	80	48	<0.3	N/A	29.4	1	Y	9-7/8"
Broan	QTXE080	Fan	6"	80	55	0.3	N/A	23.3	3	Y	7-5/8"
Delta Breez	VFB25AC	Fan	4"	80	52	<0.3	N/A	7.1	3	Y	7-63/64"
Nutone	QT Xen080	Fan	6"	80	55	0.3	N/A	23.3	3	Y	7-5/8"
Renewaire	V80	Fan	4"	80	60	<0.3	N/A	16.1	5	Y	8-1/16"
Panasonic	FV-11VQ5	Fan	4" or 6"	110	91	<0.3	0.5	21.1	3	Y	7-2/5"
Air King	ES130S	Fan	6"	130	93	<0.3	N/A	32.5	1	Y	9-7/8"
Broan	QTXE110	Fan	6"	110	90	0.7	N/A	33.5	3	Y	7-5/8"
Delta Breez	VFB25AD	Fan	4"	110	79	1.1	2.0	15.3	3	Y	7-63/64"
Nutone	QT Xen110	Fan	6"	110	90	0.7	N/A	33.5	3	Y	7-5/8"
Renewaire	V110	Fan	4"	110	93	0.8	N/A	24.2	5	Y	8-1/16"
Panasonic	FV-15VQ5	Fan	6"	150	127	<0.3	0.5	28.4	3	Y	7-2/5"
Air King	AK150LS	Fan	6"	150	116	0.8	N/A	34.8	1	Y	7-7/8"
Broan	QTXE150	Fan	6"	150	118	1.4	N/A	51.3	3	Y	7-5/8"
Marley	8140ES	Fan	4"	140	107	2.5	N/A	48.6	6	Y	7-5/8"
Nutone	QT Xen150	Fan	6"	150	118	1.4	N/A	51.3	3	Y	7-5/8"
Renewaire	V1150	Fan	6"	150	110	<0.3	N/A	32.7	5	Y	9-9/16"
Panasonic	FV-20VQ3	Fan	6"	190	144	0.8	1.4	42.0	3	Y	9-9/32"
Air King	AK200LS	Fan	6"	200	185	1.4	N/A	62.0	1	Y	9-7/8"
Broan	L200	Fan	8"	214	196	1.8	2.3	127.0	1	N	11-3/4"
Panasonic	FV-30VQ3	Fan	6"	290	257	2.0	N/A	64.0	3	Y	9-9/32"
Air King	AK300LS	Fan	6"	290	271	3.0	N/A	81.3	1	Y	9-7/8"
Broan	L300	Fan	8"	309	303	2.9	3.3	212.0	1	N	11-3/4"
Panasonic	FV-40VQ3	Fan	6"	380	348	3.0	N/A	112.0	3	Y	9-9/32"
Broan	L400	Fan	4-1/2" X 18"	442	388	2.4	2.8	146.0	1	N	11-3/4"

WhisperLite Competitive Cross Reference

Brand	Model Number	Description	Duct	CFM		Sones		Watt	Warranty (yrs)	ENERGY STAR	Housing Depth
				.1" w.g. .25" w.g.	.1" w.g. .25" w.g.						
Panasonic	FV-08VQL5	Fan-Fluorescent Light	4" or 6"	80	62	<0.3	0.4	14.9	3	Y	7-2/5"
Broan	QTXE080FLT	Fan-Fluorescent Light	6"	80	55	0.3	N/A	23.3	3	Y	7-5/8"
NuTone	QT Xen080FLT	Fan-Fluorescent Light	6"	80	55	0.3	N/A	23.3	3	Y	7-5/8"
Panasonic	FV-11VQL5	Fan-Fluorescent Light	4" or 6"	110	90	0.5	0.6	23.4	3	Y	7-2/5"
Broan	QTXE110FLT	Fan-Fluorescent Light	6"	110	90	0.7	N/A	33.5	3	Y	7-5/8"
NuTone	QT Xen110FLT	Fan-Fluorescent Light	6"	110	90	0.7	N/A	33.5	3	Y	7-5/8"
Panasonic	FV-15VQL5	Fan-Fluorescent Light	6"	150	128	0.9	1.0	31.8	3	Y	7-2/5"
Broan	QTXE150FLT	Fan-Fluorescent Light	6"	150	118	1.4	N/A	51.3	3	Y	7-5/8"
Marley	8140FL	Fan-Fluorescent Light	4"	140	107	2.5	N/A	48.6	5	Y	7-5/8"
NuTone	QT Xen150FLT	Fan-Fluorescent Light	6"	150	118	1.4	N/A	51.3	3	Y	7-5/8"

FV-05VQ5

50 CFM 4" or 6" Duct

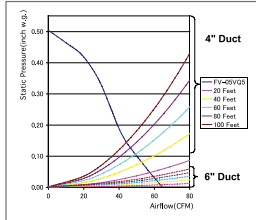

FV-11VQ5

110 CFM 4" or 6" Duct

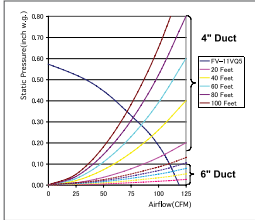

FV-08VQ5

80 CFM 4" or 6" Duct

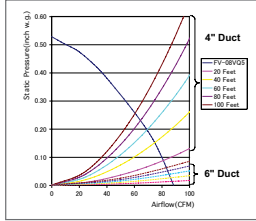

FV-15VQ5

150 CFM 6" Duct

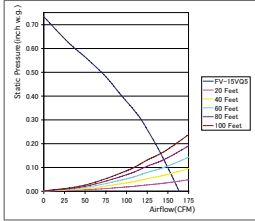

FV-20VQ3

190 CFM 6" Duct

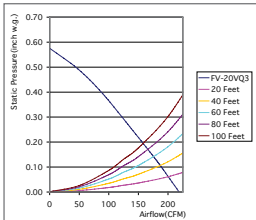

FV-30VQ3

290 CFM 6" Duct

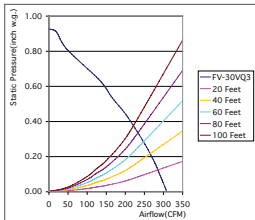

FV-40VQ3

380 CFM 6" Duct

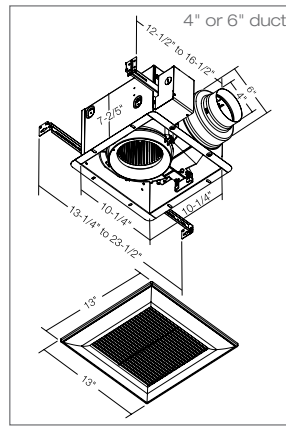
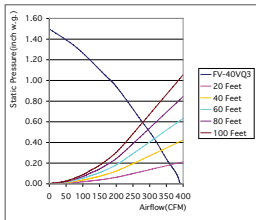

FV-05VQ5/FV-08VQ5/FV-11VQ5

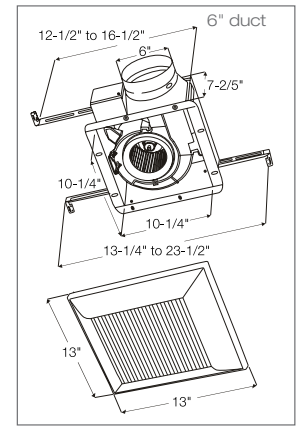

FV-15VQ5

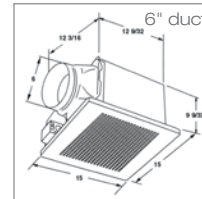

FV-20VQ3/FV-30VQ3

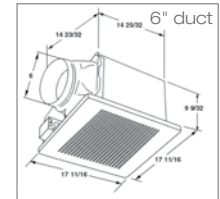

FV-40VQ3

FV-08VQL5

80 CFM 4" or 6" Duct

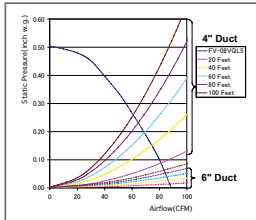

FV-15VQL5

150 CFM 6" Duct

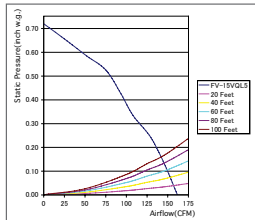

FV-11VQL5

110 CFM 4" or 6" Duct

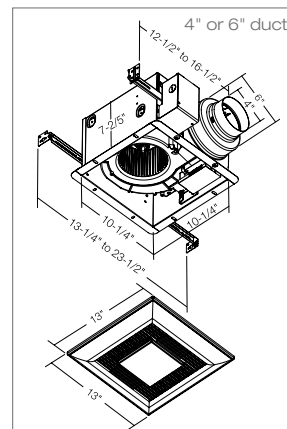
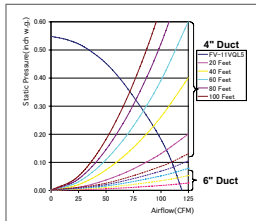

FV-08VQL5/FV-11VQL5

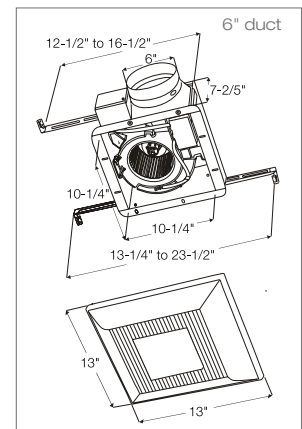

FV-15VQL5



Printed with soy ink on 10% post-consumer recycled paper.

Panasonic Home & Environment Company
Unit of Panasonic Corporation of North America

Headquarters

Panasonic Home & Environment Company
One Panasonic Way
Secaucus, NJ 07094

www.panasonic.com/building

Customer Service

Panasonic Home & Environment Company
5201 Tollview Road
Rolling Meadows, IL 60008

For Order Information

PHONE: 866-292-7299
FAX: 888-553-0723

ventfans@us.panasonic.com

Design and specifications subject to change without notice.